



DMX 32



Operator panel with integrated PLC

- Fixing system on din rail
- High speed (2msec. standard cycle time)
- Contact programming with Ladder language
- Function for Recipe management , P.I.D. Regulator , Print etc ...

ELECTRIC CHARACTERISTICS	
Power supply voltage	Min 20 Vcc ; Max 26 Vcc Min 15 Vac ; Max 21 Vac
Current Consumption	Under 50mA without loads
Microprocessor	Hitachi H8S/2145B @ 20MHz
Program Memory	64 KB
Pages Memory	64 KB
E ² PROM	64 KB
Cycle Time	Programmable (minimum 1 msec.)



Digital Inputs	16 digital inputs PNP 24 Volts of which 4 fast input (1KHz for encoder reading) with programmable anti-noise filter (value 1..16)
Analog Inputs	No analogic inputs
Digital Outputs	16 relay outputs 24V , 5A for any common
Analog Outputs	No analog outputs
Plugged RAM	79 words any 100 msec automatically copy into plugged RAM (for a term of 1 year)
RTC	Extern real time clock with plugged calendar and clock with rechargeable battery . (for a term of 1 year)

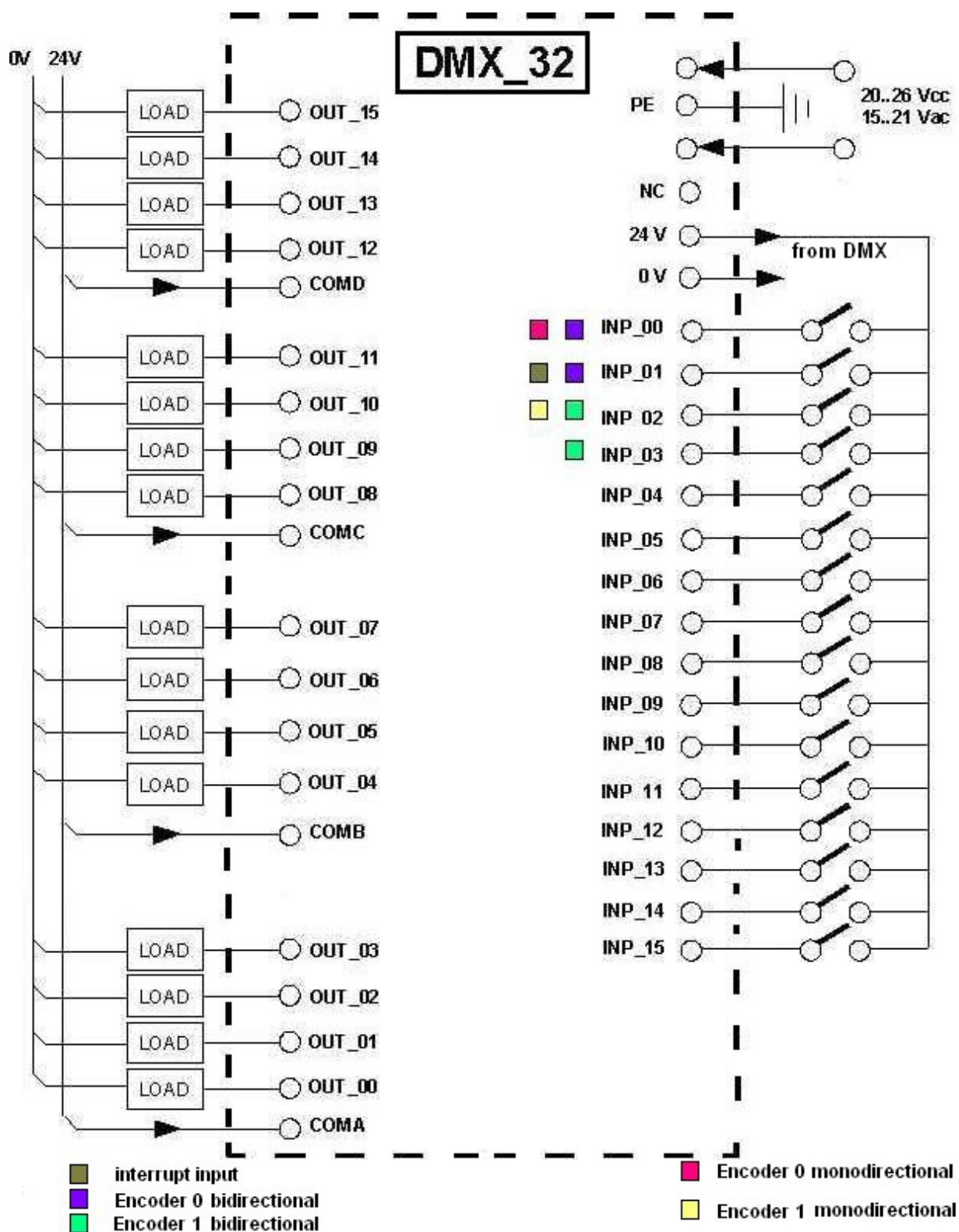

Serial Lines

2 serial lines (COM 0 e COM 1) with the possibility of replace COM 1 with Ethernet.

COM 0 : It could be used in RS232, RS485 or RS422 mode with many different standard communication protocols for connect other devices (I/O expansions , termoregulators , inverters or network connection) .

COM 1 : It could be used in RS232, RS485 mode and it's used like COM0 , besides for upload applications or operative system .

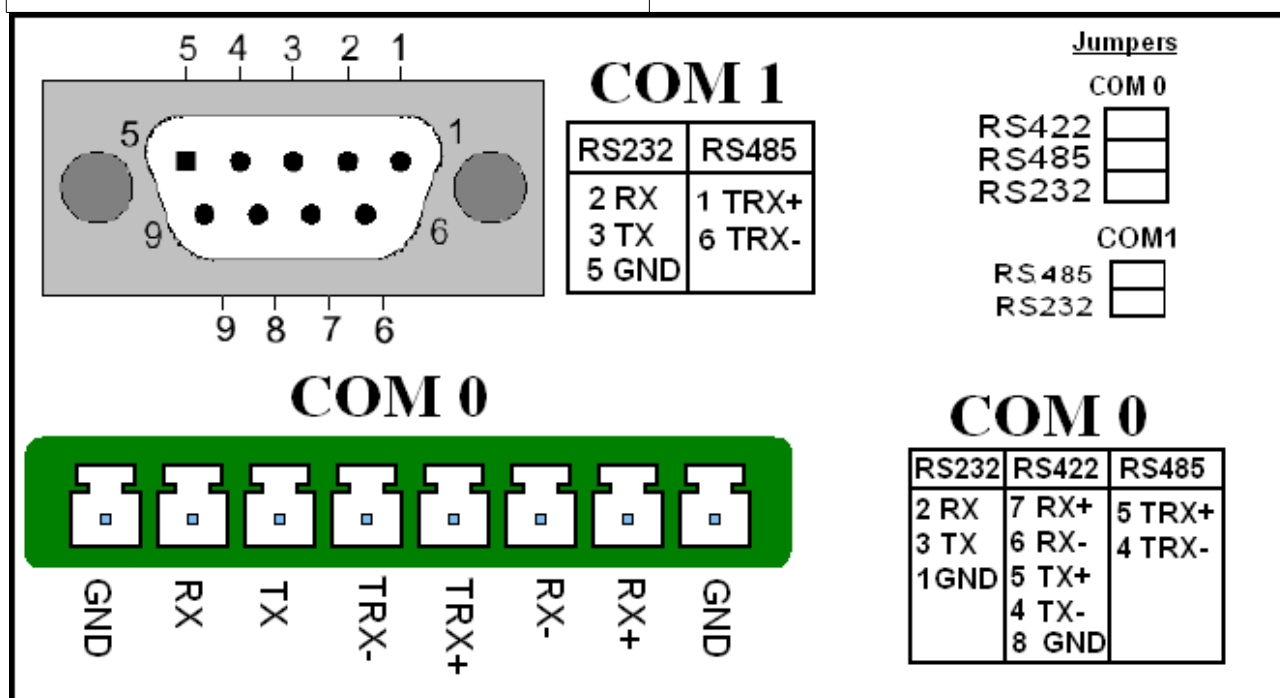

MECHANICS CHARACTERISTICS

Temperature Range	from -10 °C to +70 °C
Humidity Range	from 10 to 90% (non-condensing)
Operating Atmosphere	Without corrosive gas
Noise Immunity	According to rules in force
Fixing System	On din rail
Weight	450 gr
Keyboard	4 dedicated buttons
Display	Alphanumeric display 16 characters on 2 rows , backlight LED

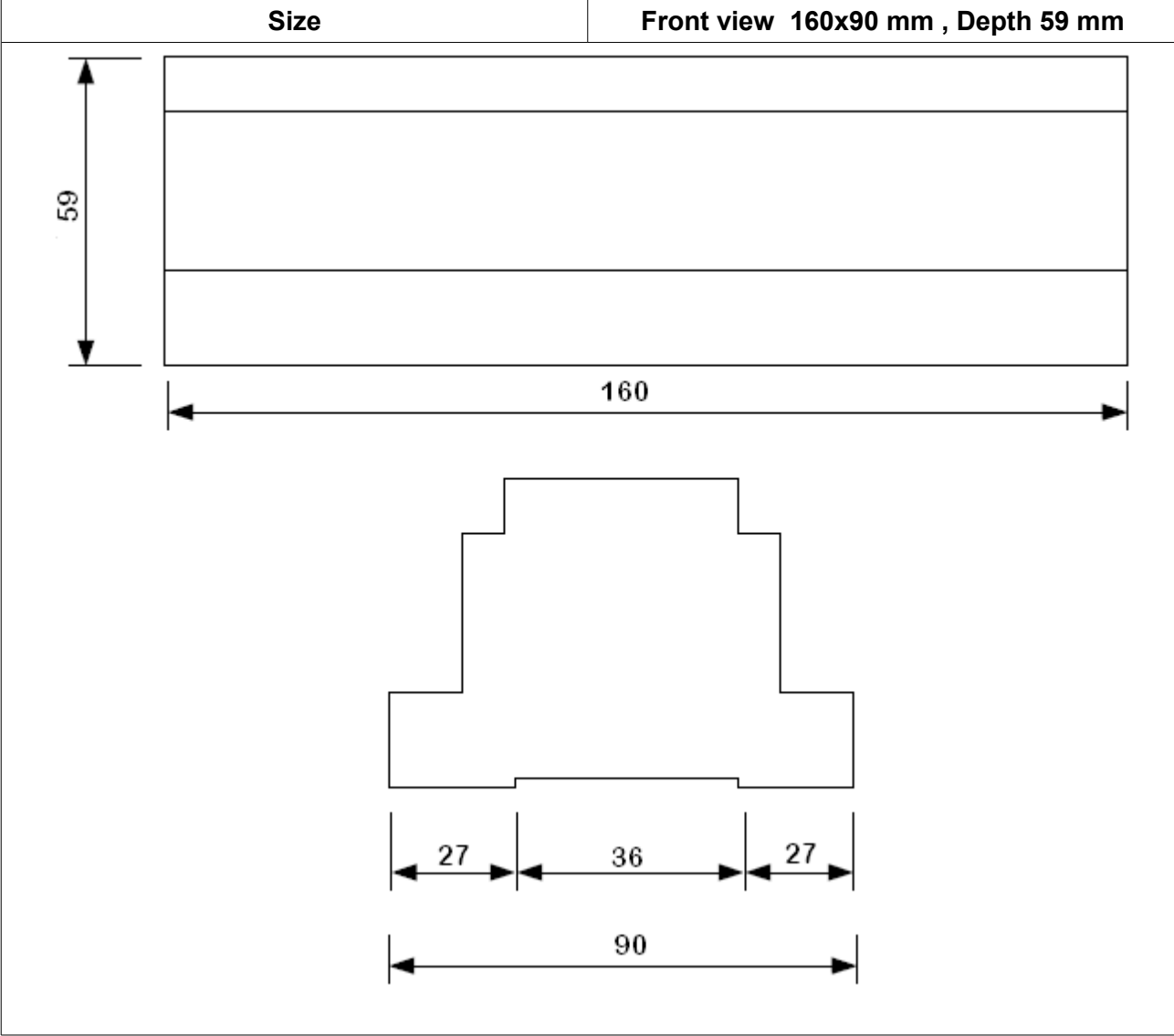



SOFTWARE CHARACTERISTICS	
Programming Languages	AWL / Ladder
Timers	64 timers with 16 bits and resolution 1/100 sec . 32 configurable timers one by one like excitation delay or disexcitation delay and 32 only excitation timers . 8 timers free running with 1 msec resolution enabled one by one with system flag .
Counters	32 counters with 16 bits configurable one by one like incremental or decremental .
Data Memory	2048
Developed Functions	<ul style="list-style-type: none"> - Week Programming - Recipe Management - Encoders Management - P.I.D. Temperature's Regulator - Forwarding/Reception SMS Messages
Memory area check in real time mode on data table (Debug)	●
Ladder's subroutines Import/Export	●
Contact and variable check in real time mode on ladder (Debug Online)	●